

# Ethnicraft

## ASSEMBLY INSTRUCTION FOR ANTI-TIPPING INSTALLATION

### HARDWARE ENCLOSED

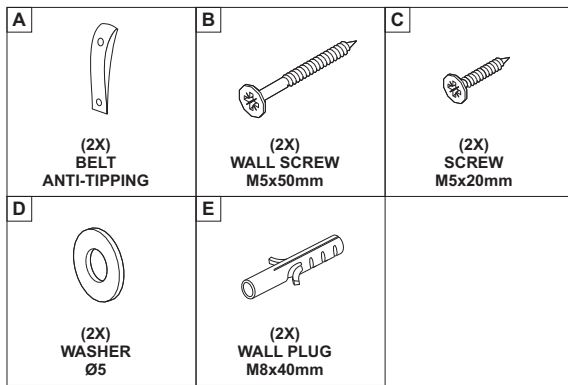

### TOOLS

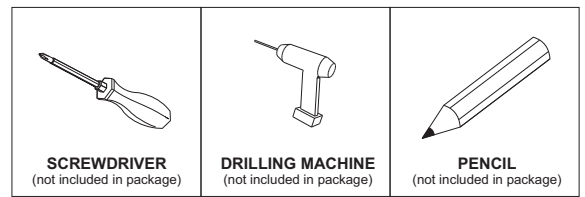

### INSTALLING ANTI-TIPPING SYSTEM



AS WALL MATERIALS VARY,  
THE SCREW INCLUDED ARE FOR BRICK WALL.  
FOR ADVICE ON SUITABLE SCREW SYSTEMS,  
CONTACT YOUR LOCAL SPECIALISED DEALER.

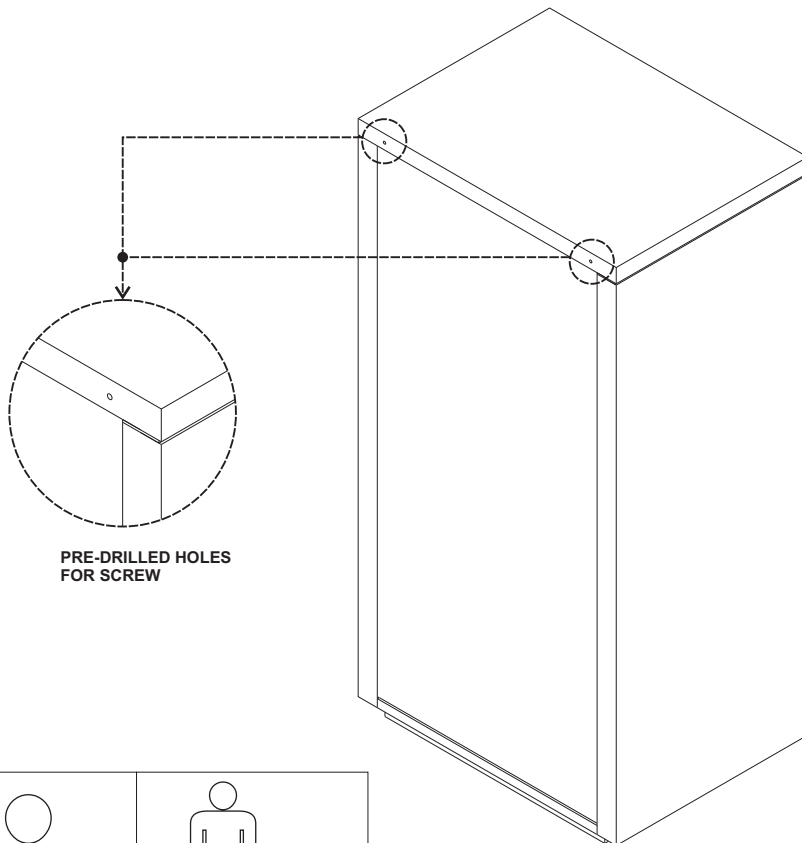

### NOTICE

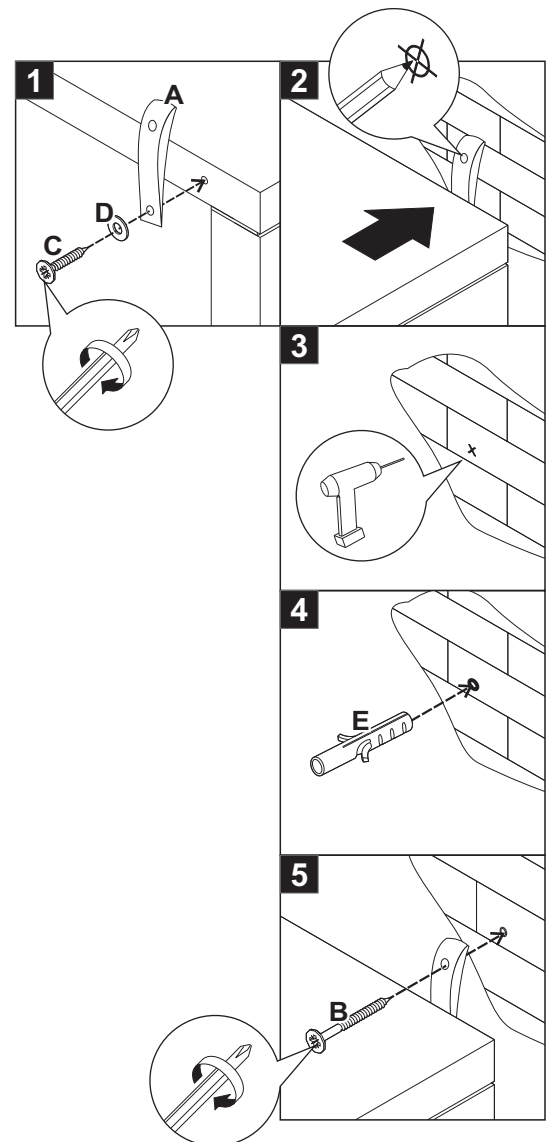
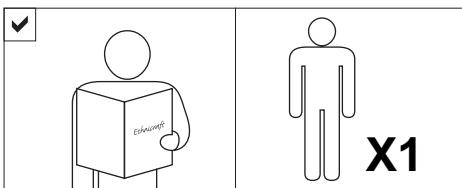

### INSTRUCTION

1. Install anti-tipping belt (A), washer (D) with M5x20mm screw (C) into the pre-drilled hole on the top back frame of the cabinet.
2. Using a 1/4" diameter drill bit, drill the wall at the same level as the anti-tipping belt (A) on the cabinet. Install the wall plug (E) into the hole.
3. Connect the anti-tipping belt (A) with wall screw (B) into the wall plug (E).